

CSP 305A

Conduction-cooled capacitor

Technology Patented Worldwide

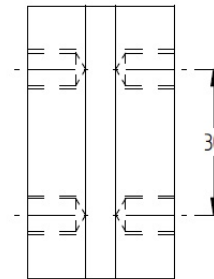
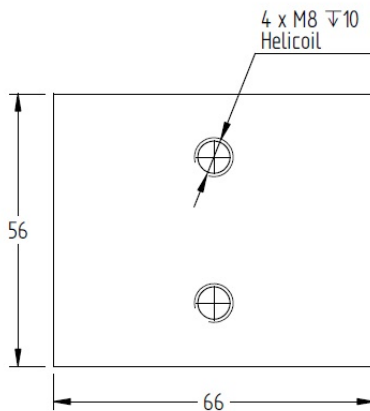
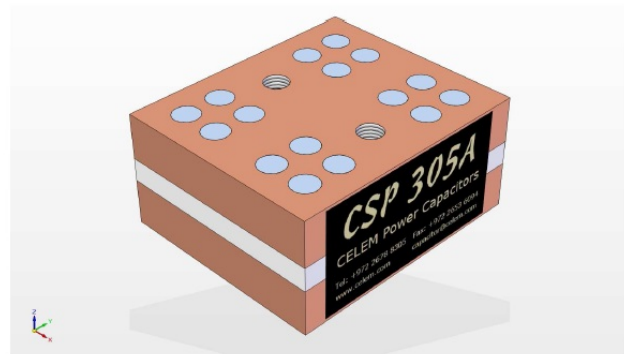

The CSP 305A and CSP 305B conduction-cooled capacitors provide up to 300 kVAr of power.

These capacitors have similar electrical characteristic but differ in their physical dimensions and in the number of holes used to mount the capacitor.

Please note that the newer CSP 405A and CSP305A/600 have the same physical dimensions as the CSP 305A but are rated for higher voltage and higher current and can carry up to 400 and 600kVAr respectively.

Specifications

Type		CSP 305A							
Dimensions (L x W x H)	mm	66 x 56 x 30.2							
Weight	kg	0.6							
Capacitance (±10%)	μF	0.1μF	0.2μF	0.33μF	0.66μF	1μF	1.32μF	2.6μF	5μF
Sinusoidal Voltage	V _{rms}	1000		700		600		500	400
Peak Voltage	V	1410		990		850		710	570
Max. Current	A _{rms}	350	400	500		650		800	
Max. Power	kVA _r	300							
Freq Range @ Full Power	kHz	477-650	239-424	295-402	148-201	133-224	100-170	73-86	60-68
Stray Inductance	nH	<5							

Celem Power Capacitors

Produced: 03-09-2015

CSP 305A

Conduction-cooled capacitor

Technology Patented Worldwide

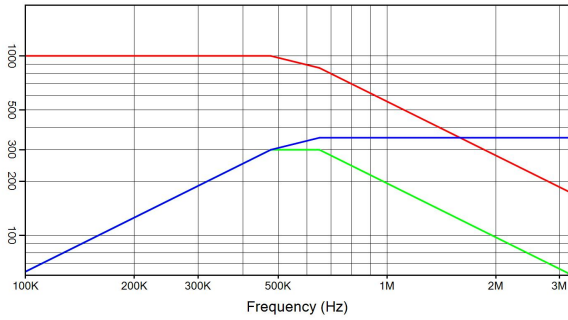

CSP 305A 0.1 μF 1000 V_{rms} 350 A_{rms} 300 kVA_r
 I(A) — Q(kVA_r) — V_{rms}

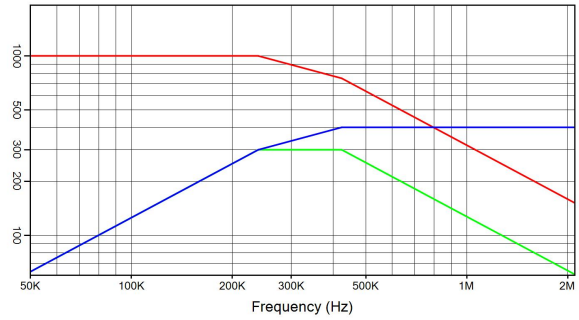

CSP 305A 0.2 μF 1000 V_{rms} 400 A_{rms} 300 kVA_r
 I(A) — Q(kVA_r) — V_{rms}

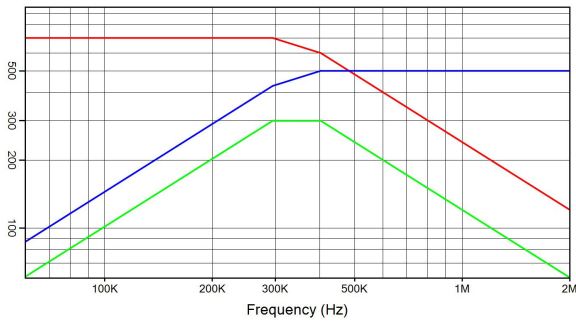

CSP 305A 0.33 μF 700 V_{rms} 500 A_{rms} 300 kVA_r
 I(A) — Q(kVA_r) — V_{rms}

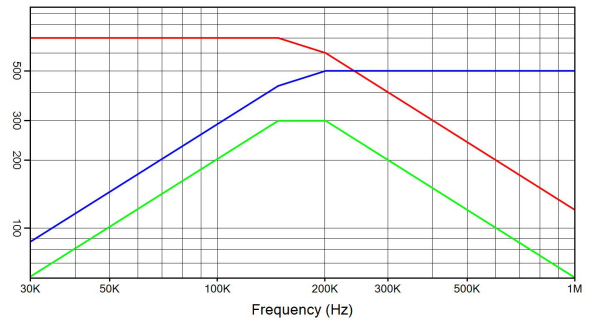

CSP 305A 0.66 μF 700 V_{rms} 500 A_{rms} 300 kVA_r
 I(A) — Q(kVA_r) — V_{rms}

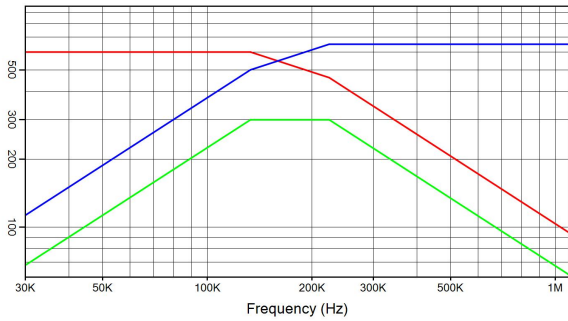

CSP 305A 1 μF 600 V_{rms} 650 A_{rms} 300 kVA_r
 I(A) — Q(kVA_r) — V_{rms}

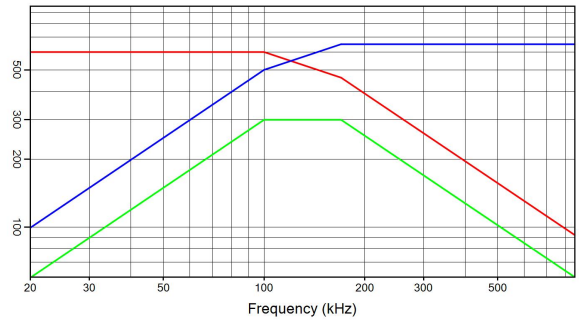

CSP 305A 1.32 μF 600 V_{rms} 650 A_{rms} 300 kVA_r
 I(A) — Q(kVA_r) — V_{rms}

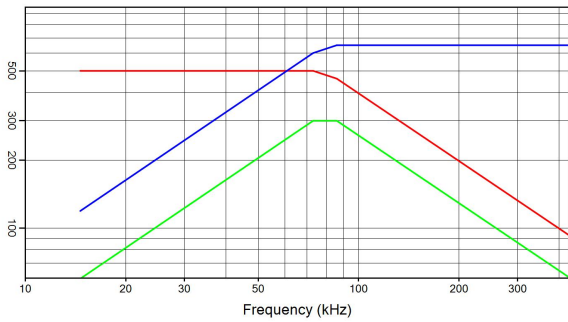

CSP 305A 2.6 μF 500 V_{rms} 650 A_{rms} 300 kVA_r
 I(A) — Q(kVA_r) — V_{rms}

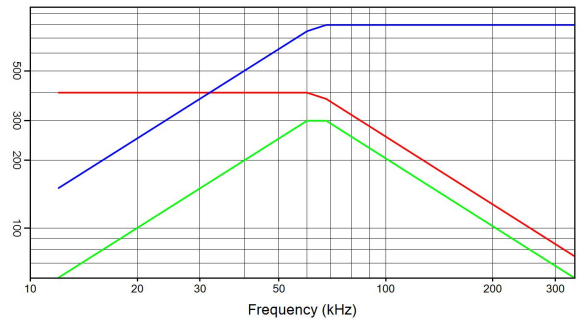

CSP 305A 5 μF 400 V_{rms} 800 A_{rms} 300 kVA_r
 I(A) — Q(kVA_r) — V_{rms}

Celem Power Capacitors

Produced: 03-09-2015